

MD2030C, MD2030D

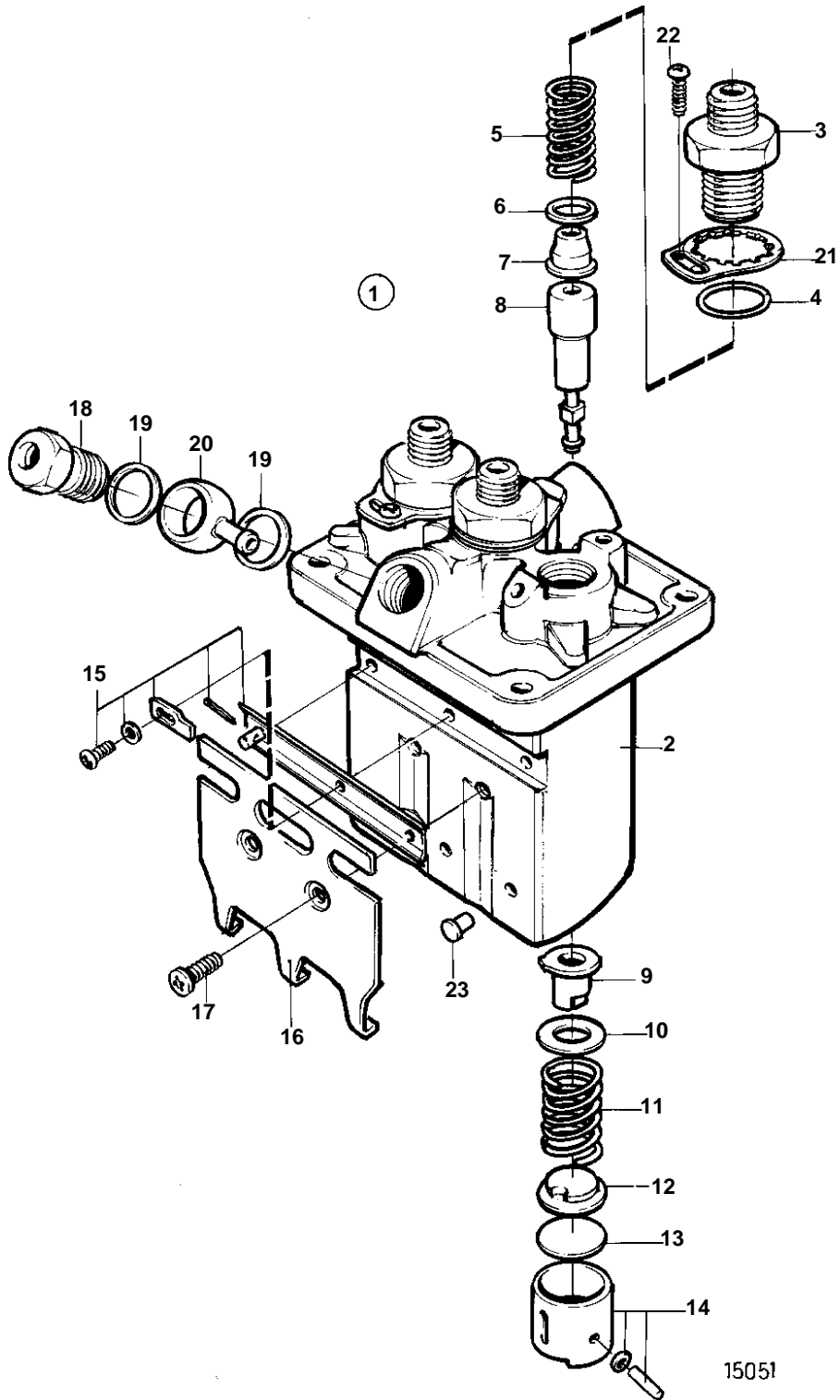

MD2030C, MD2030D

REF	PART NO.	QTY	DESCRIPTION	NOTES
1	3580382	1	Injection pump	
2	3580274	1	· Housing	
3	3580402	3	· Delivery valve retai	
4	3580124	3	· O-ring	
5	3580125	3	· Spring	
6	3580276	3	· Gasket	
7	3580128	3	· Delivery valve	
8	3580403	3	· Pump element	
9	3580130	3	· Control sleeve	
10	3580131	3	· Washer	
11	3580132	3	· Spring	
12	3580133	3	· Washer	
13	3580134	X	· Shim	TH = 1,85mm
	3580135	X	· Shim	TH = 1,90mm
	3580136	X	· Shim	TH = 1,95mm
	3580137	X	· Shim	TH=2,00mm
	3580138	X	· Shim	TH=2,05mm
	3580139	X	· Shim	TH=2,10mm
	3580140	X	· Shim	TH=2,15mm
	3580141	X	· Shim	TH=2,20mm
	3580142	X	· Shim	TH=2,25mm
	3580143	X	· Shim	TH=2,30mm
	3580144	X	· Shim	TH=2,35mm
	3580145	X	· Shim	TH=2,40mm
	3580146	X	· Shim	TH=2,45mm
	3580147	X	· Shim	TH=2,50mm
14	3580148	3	· Tappet	
15	3580278	1	· Control rod	
16		1	· Bracket	
17	3580151	2	· Screw	
18	3580152	1	· Hollow screw	
19	907132	2	· Gasket	(3580153)
20	3580154	1	· Banjo nipple	
21	3580155	3	· Lock plate	
22	3580156	3	· Screw	
23	3580157	3	· Lock pin	